

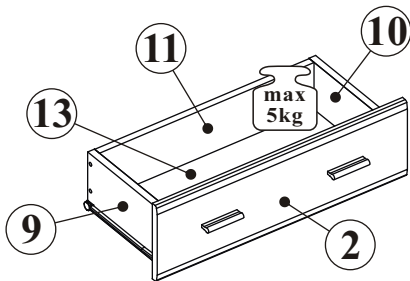

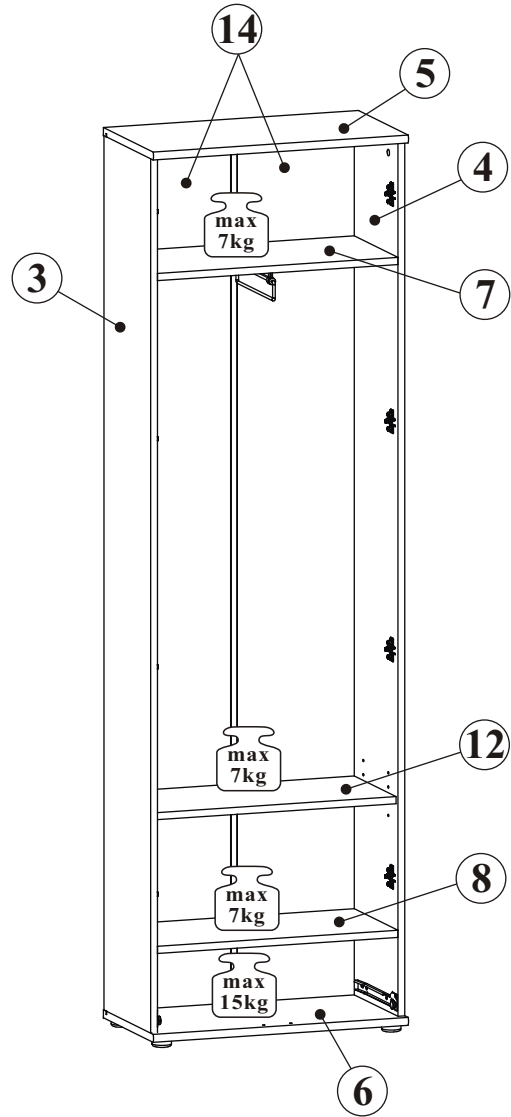

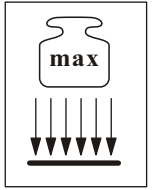

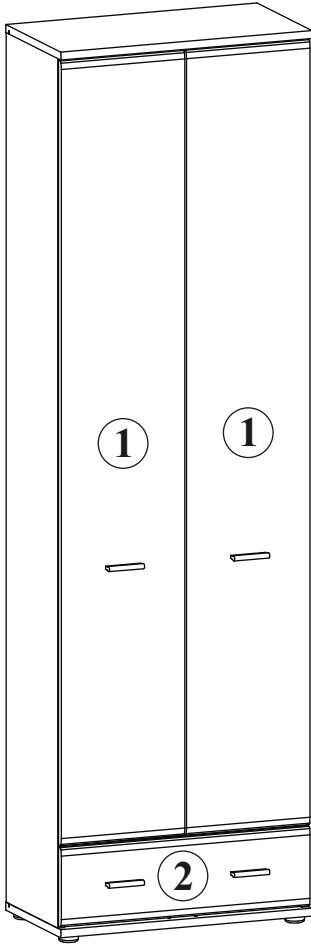

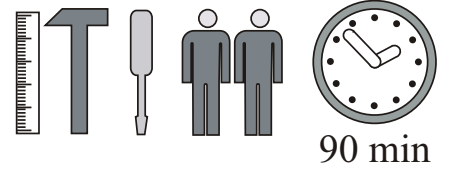

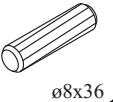
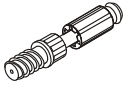
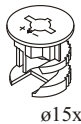

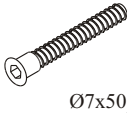

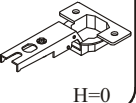
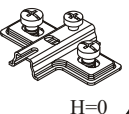

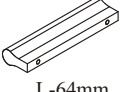
ARMARIO 1 ECO TYP A

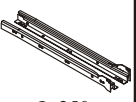

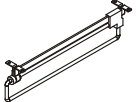
NO	Dim.			Col.-No	Qty
1	1778	296	16	1	2
2	596	180	16	1	1
3	1970	300	16	1	1
4	1970	300	16	1	1
5	602	322	18	1	1
6	602	322	18	1	1
7	568	280	16	1	1
8	568	280	16	1	1
9	250	132	16	1	1
10	250	132	16	1	1
11	511	112	16	1	1
12	568	268	16	1	1
13	523	253	3	1	1
14	1981	288	3	1	2

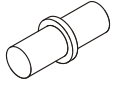
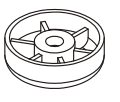

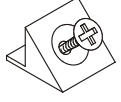
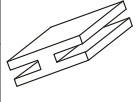
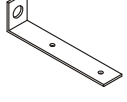
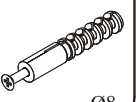

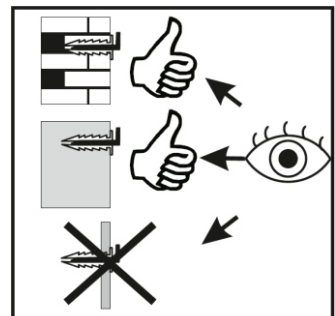
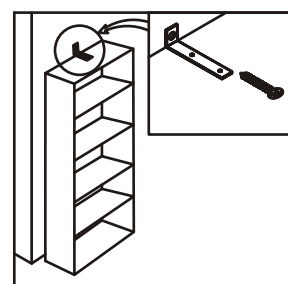
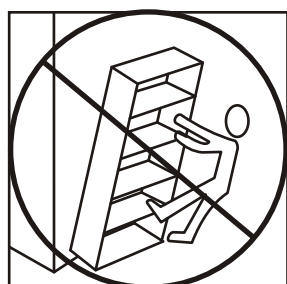
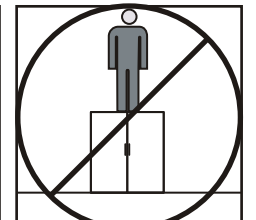
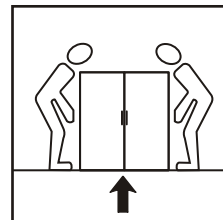
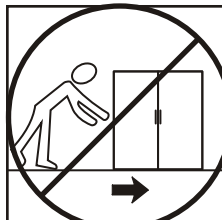
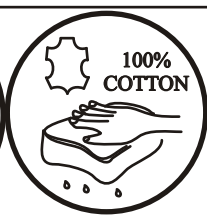
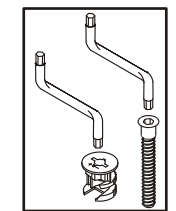
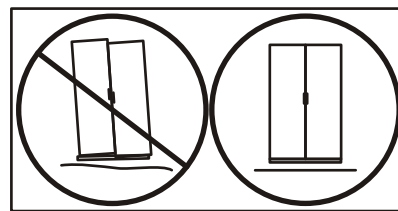
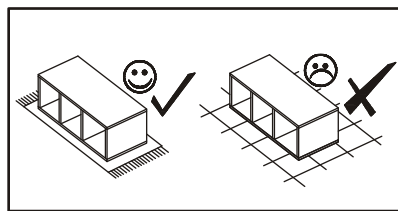
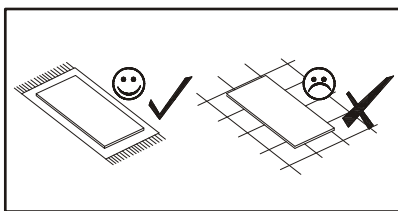
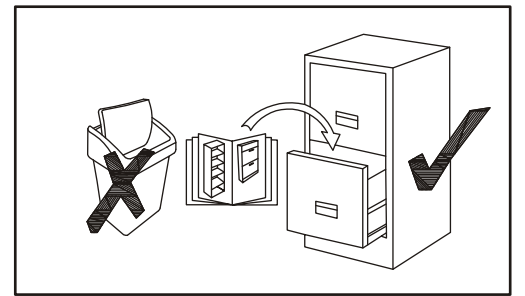
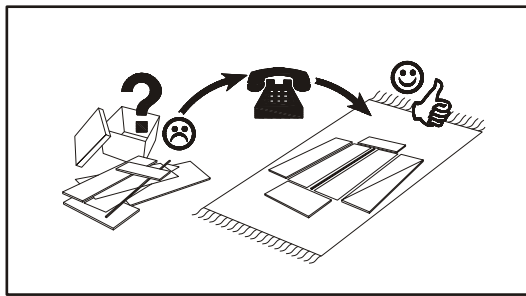
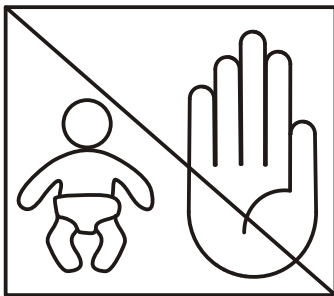
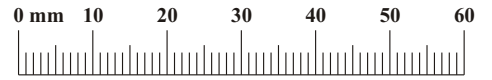

ARMARIO 1 ECO TYP A

A1 x20  ø8x36	B4 x14 	B5 x14  ø15x12	G5 x14 	B11 x8  Ø7x50	G4 x8 
E1 x8  H=0 Ø26	E2 x8  H=0	D10 x22  USØ3,5x13	KL x4  L-64mm	UP6 x8  UPØ4x30	Z2 x4  Ø5
H5 x1  L-250mm	D8 x4  ESØ5x13	B3 x15  Ø1,4x25	C6 x1 	UP17 x4  UPØ3x16	G7 x4 
I11 x4 	UP11 x4  UPØ4x20	S1 x18 	G8 x1 	L1 x1 	KR1 x1  Ø8
G2 x1 					

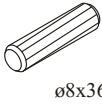

ARMARIO 1 ECO TYP A

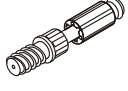
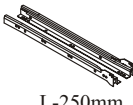
1

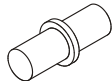
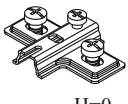
A1		B5		B4	
x8	ø8x36	x4	ø15x12	x8	
H5		D8		G7	
x1	L-250mm	x4	ESØ5x13	x4	
E2					
x8	H=0				

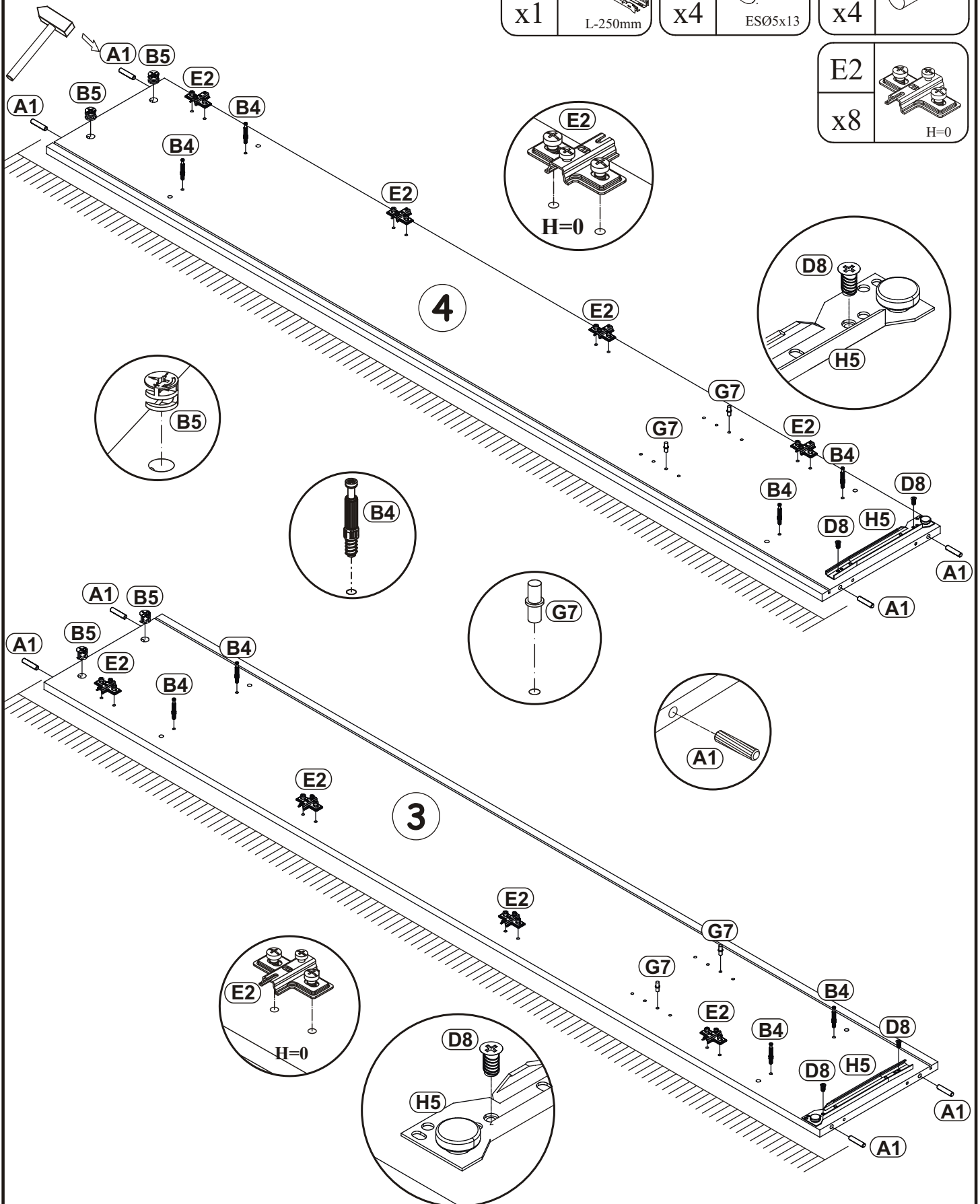

ARMARIO 1 ECO TYP A

2

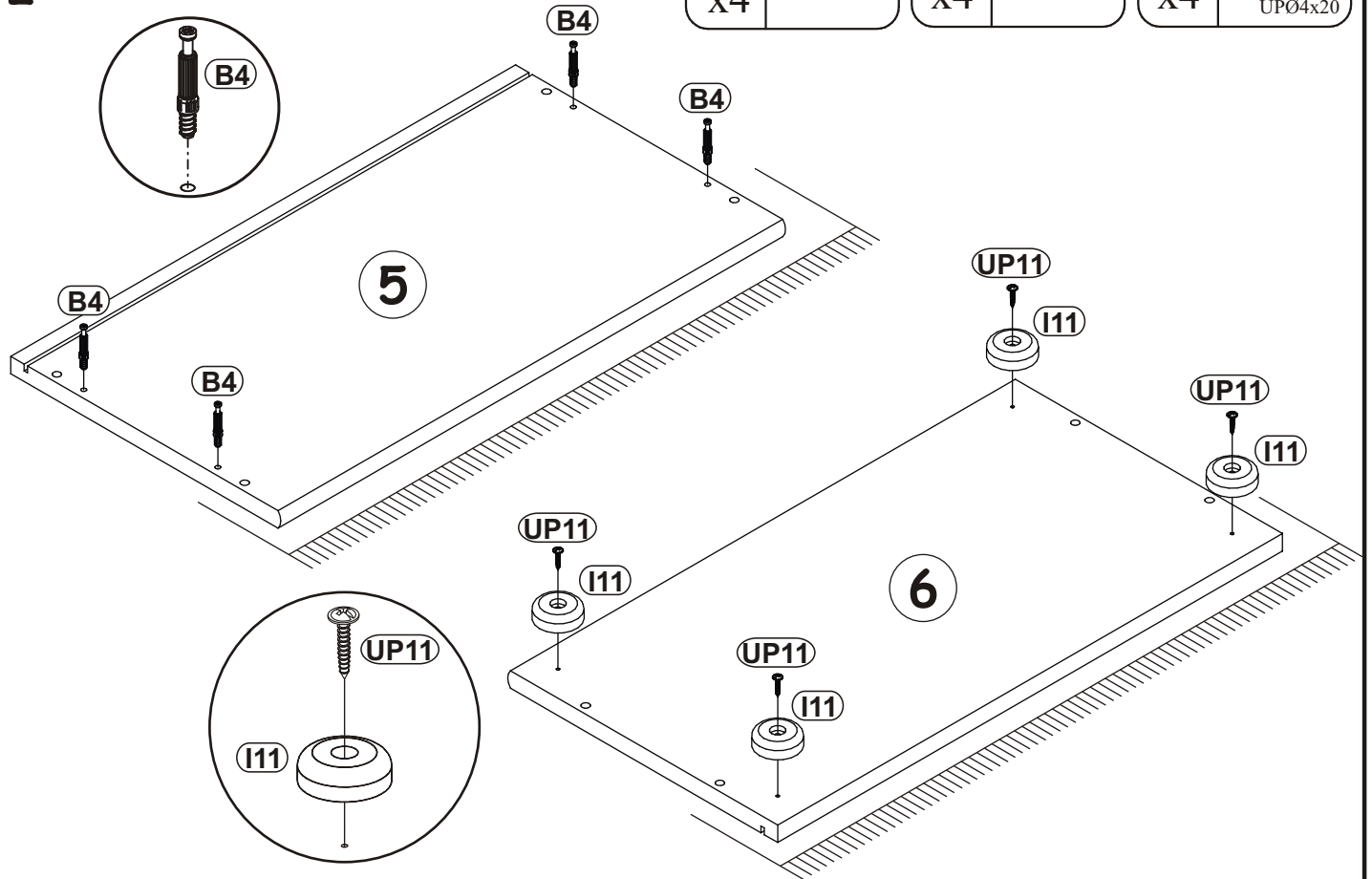

B4	
x4	

I11	
x4	

UP11	
x4	UPØ4x20

3

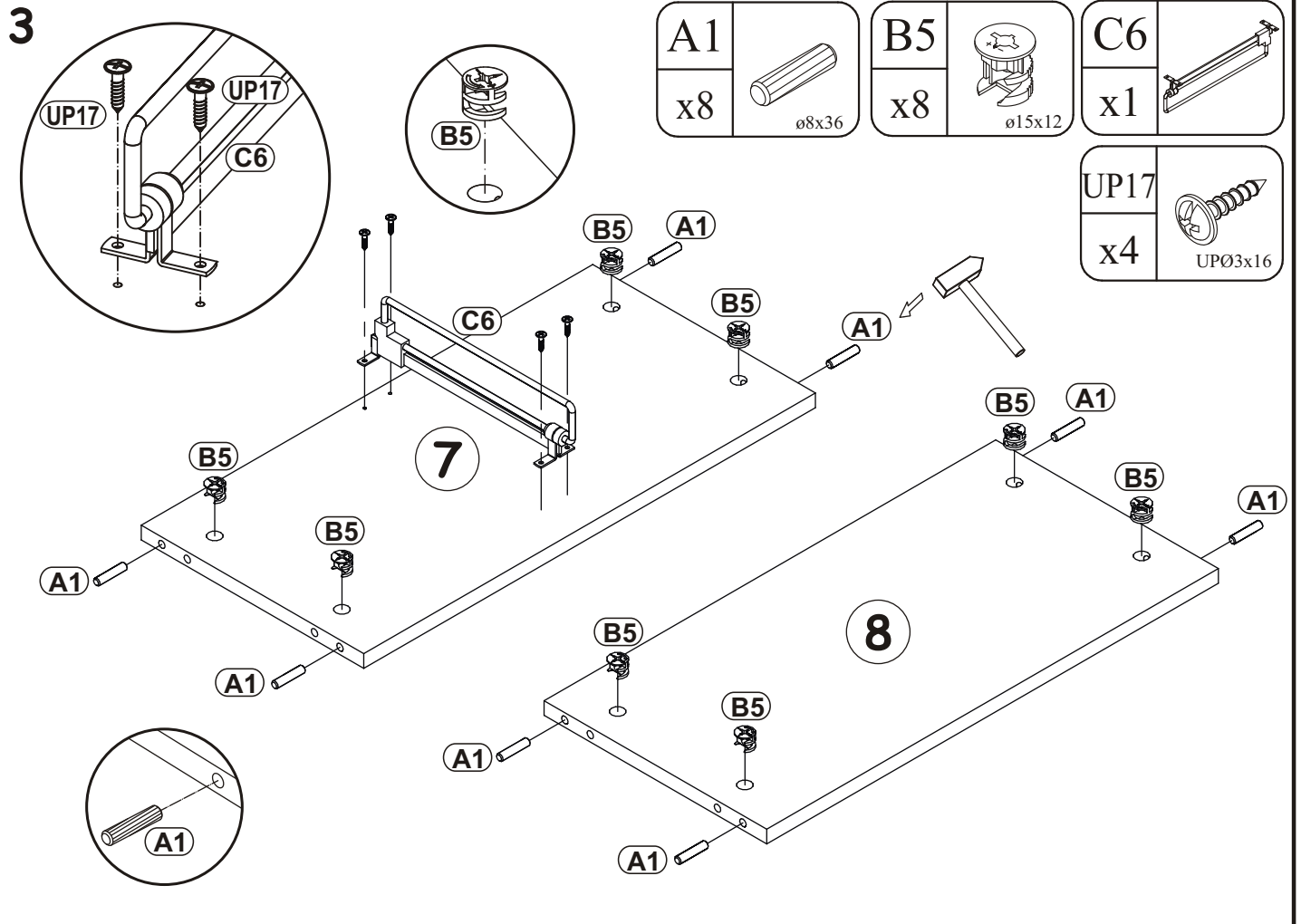

A1	
x8	ø8x36

B5	
x8	ø15x12

C6	
x1	

UP17	
x4	UPØ3x16

ARMARIO 1 ECO TYP A

4

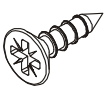
E1	Ø26	D10	 USØ3,5x13
x8	H=0	x16	

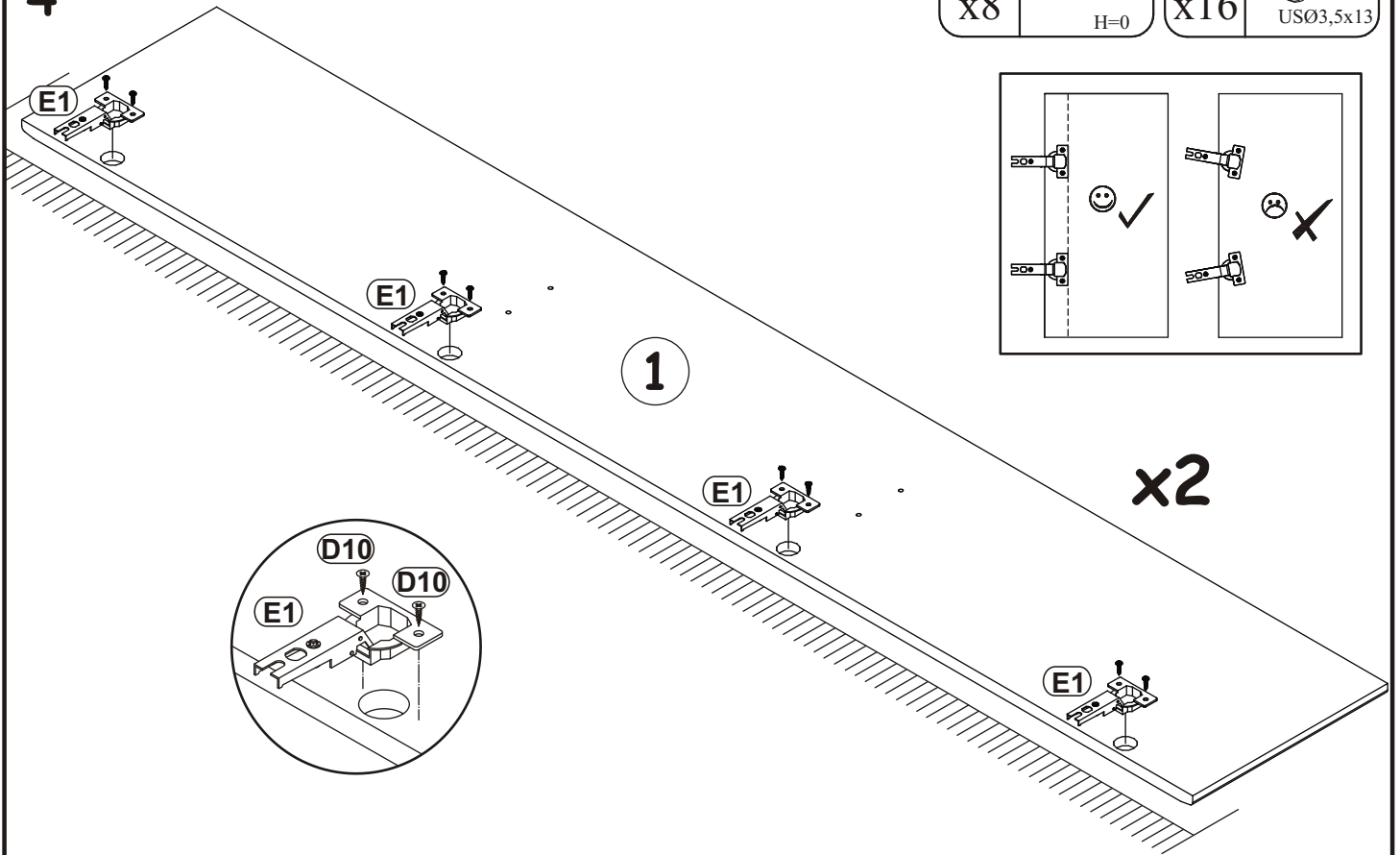

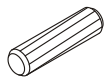
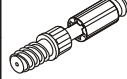
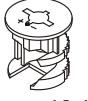

5

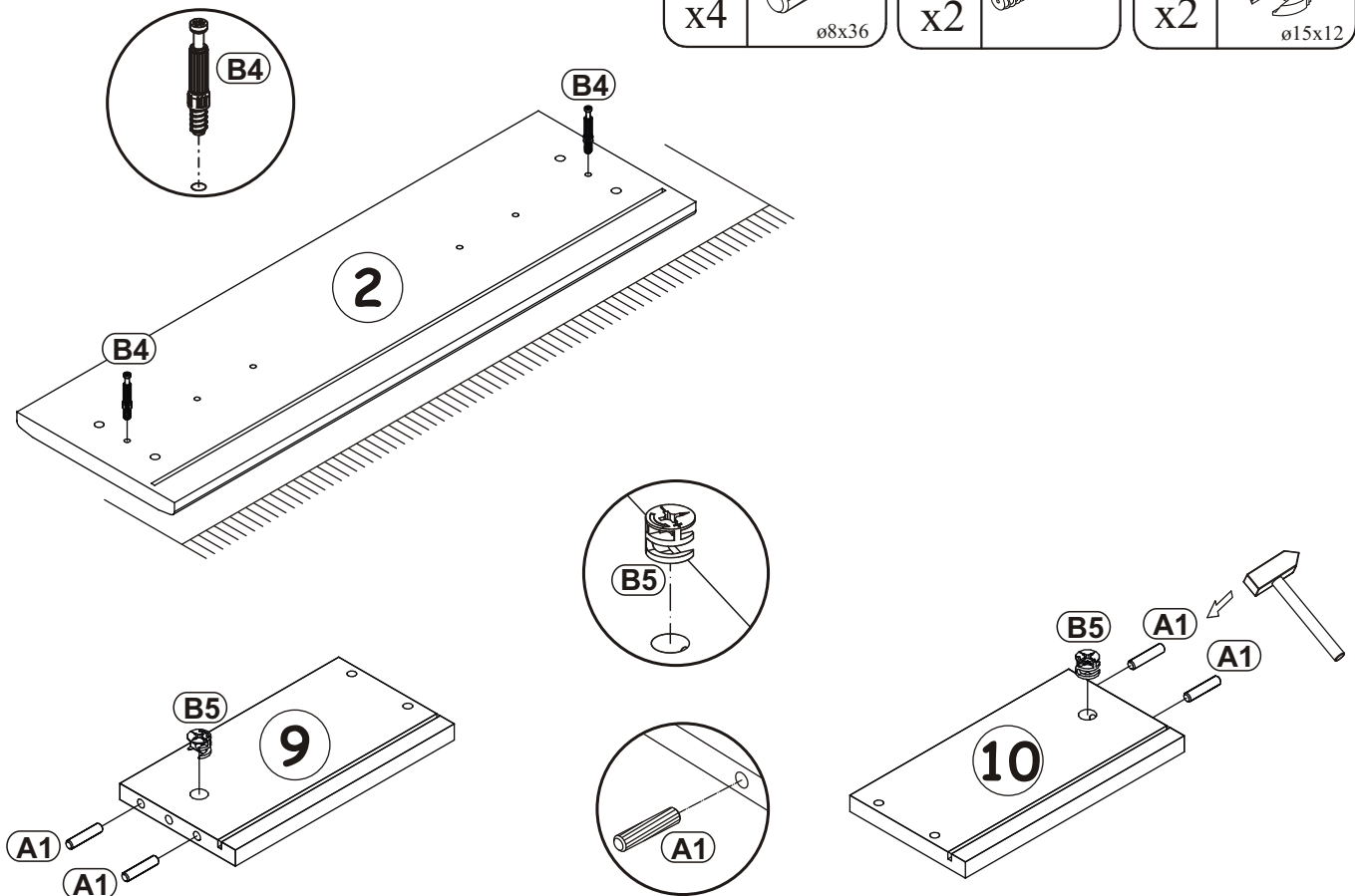
A1	 ø8x36	B4		B5	 ø15x12
x4		x2		x2	



6

B11		G4	
x4	Ø7x50	x4	

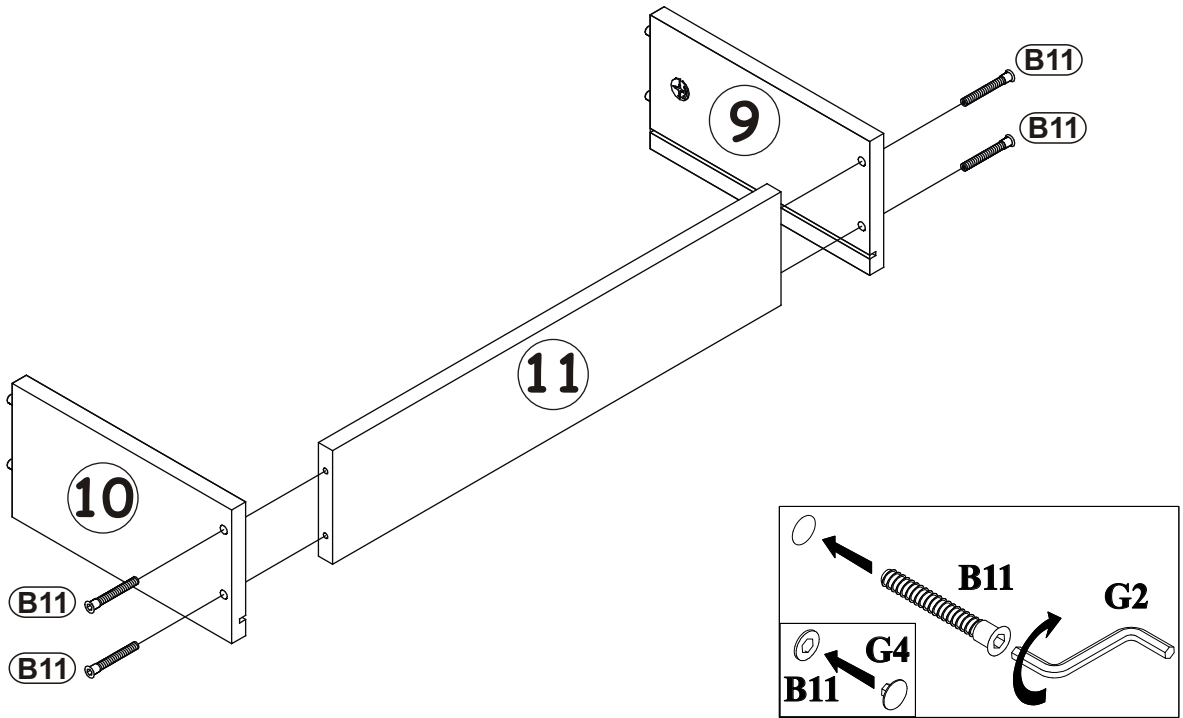

7

G5	
x2	

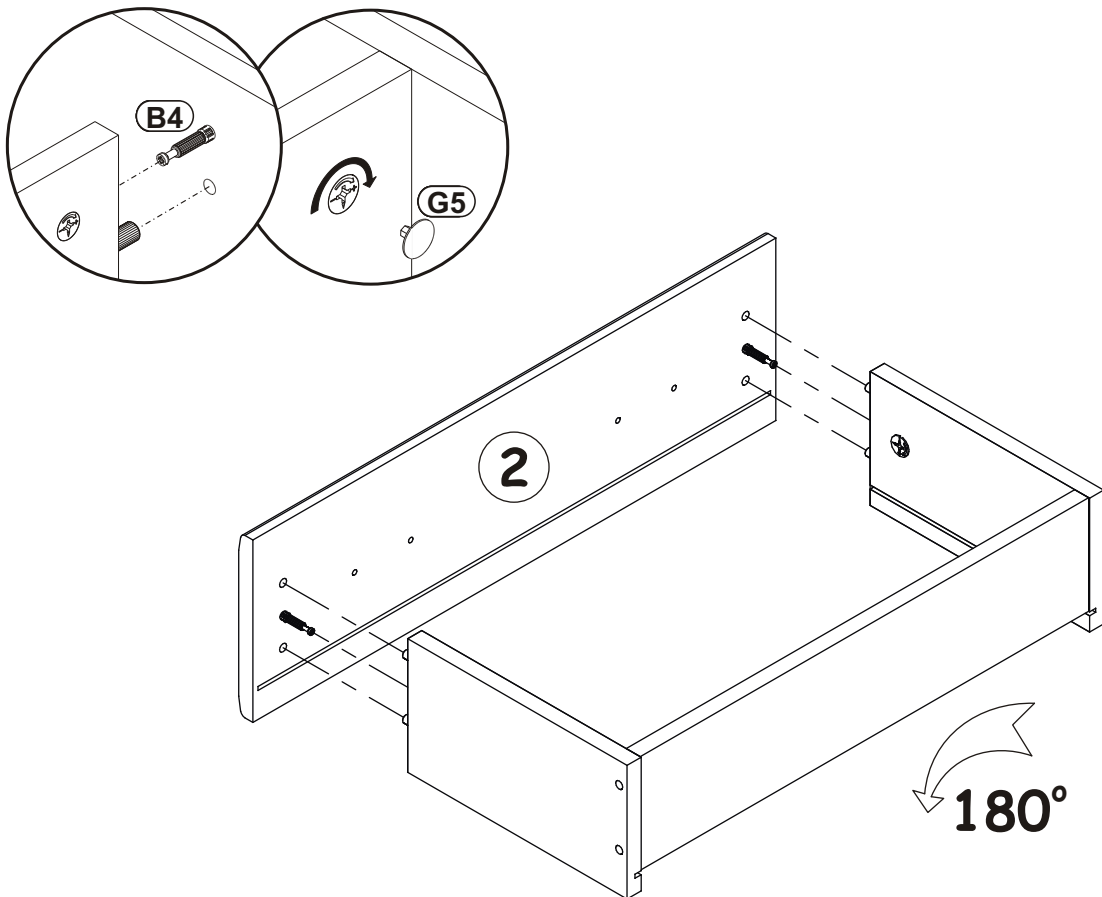

8

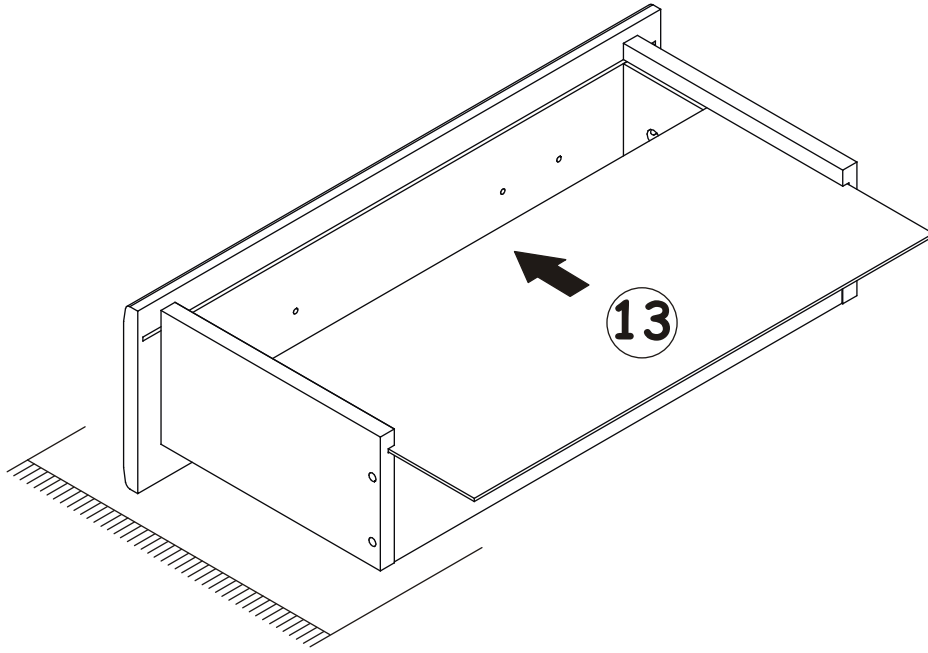

9

H5	
x1	L-250mm

D10	
x4	USØ3,5x13

B3	
x5	Ø1,4x25

S1	
x2	

X=Y 90°

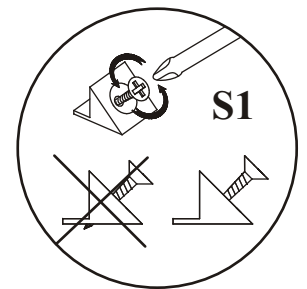
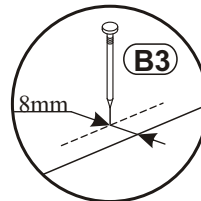
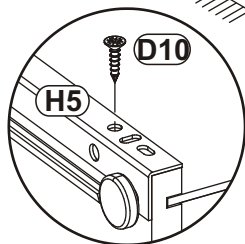
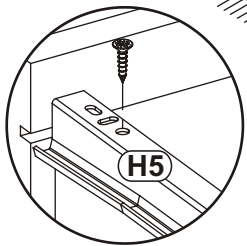
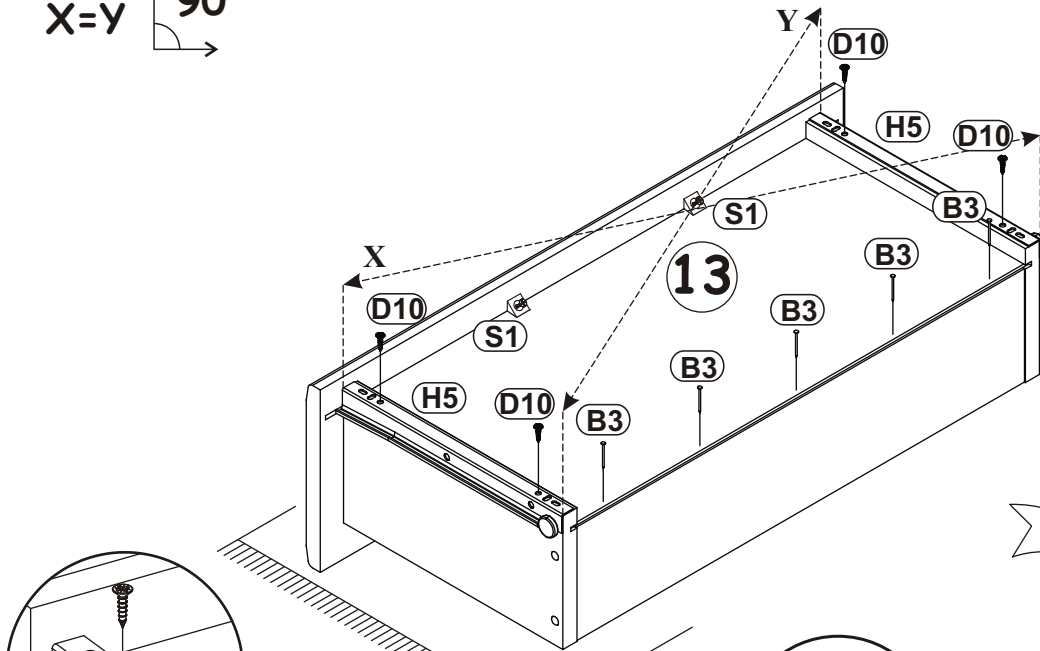

10

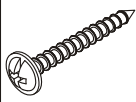
KL		UP6	
x2	L-64mm	x4	UPØ4x30

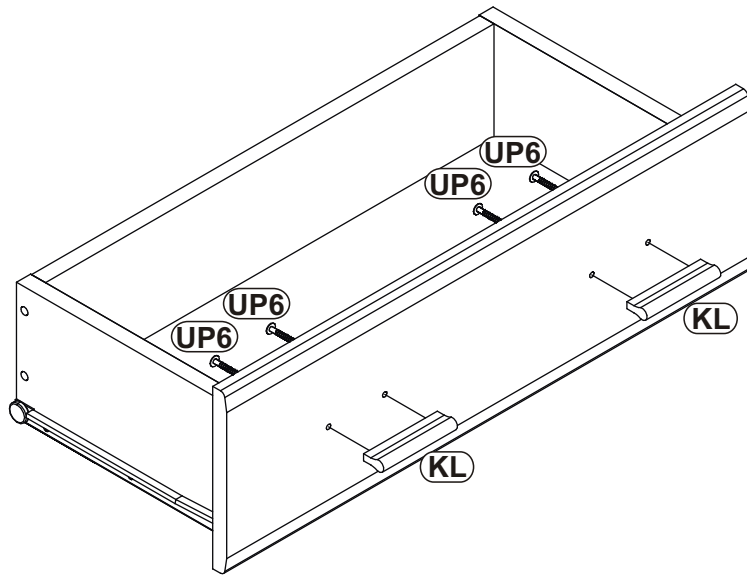

11

G5	
x8	

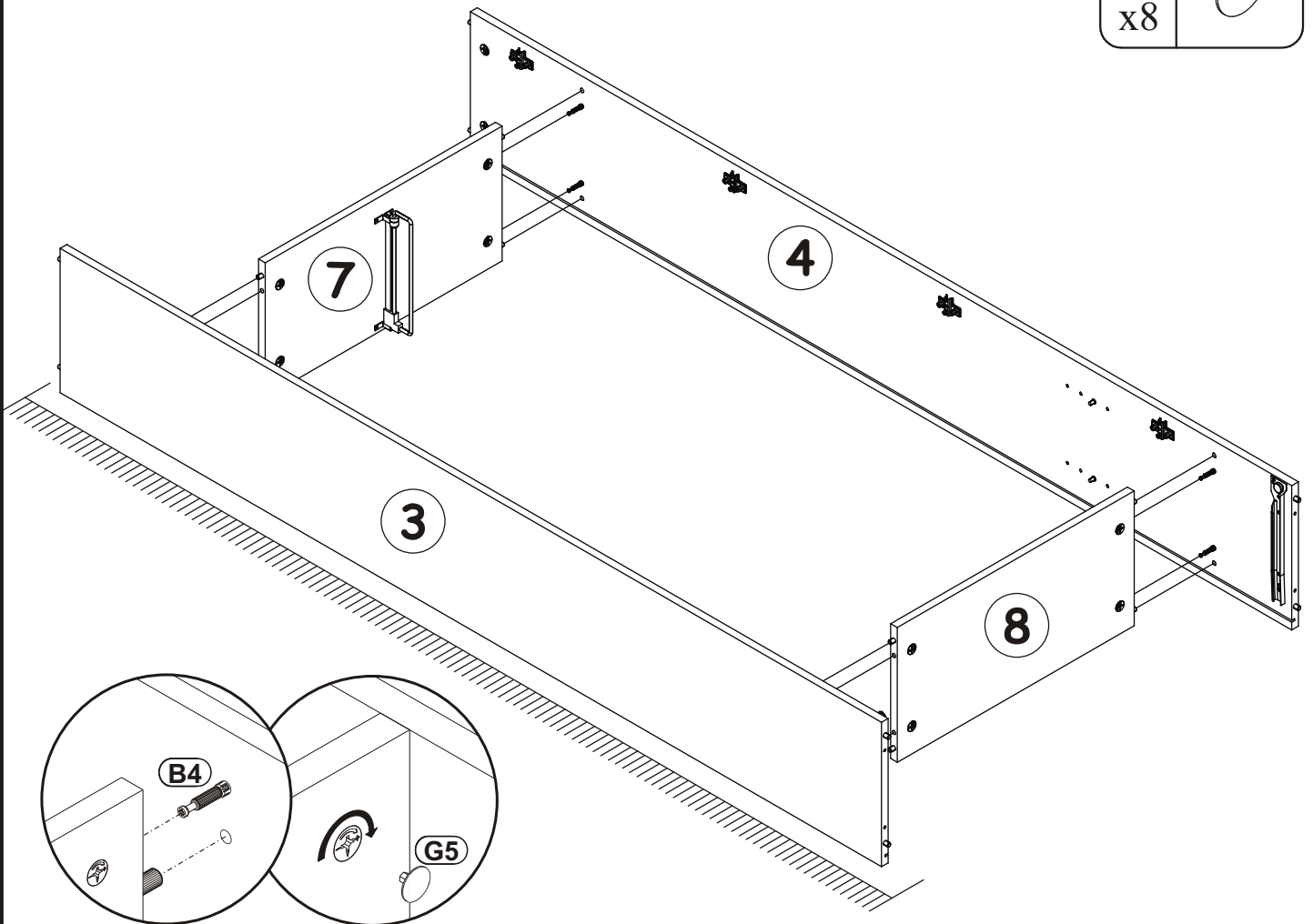

G5	
x4	

12

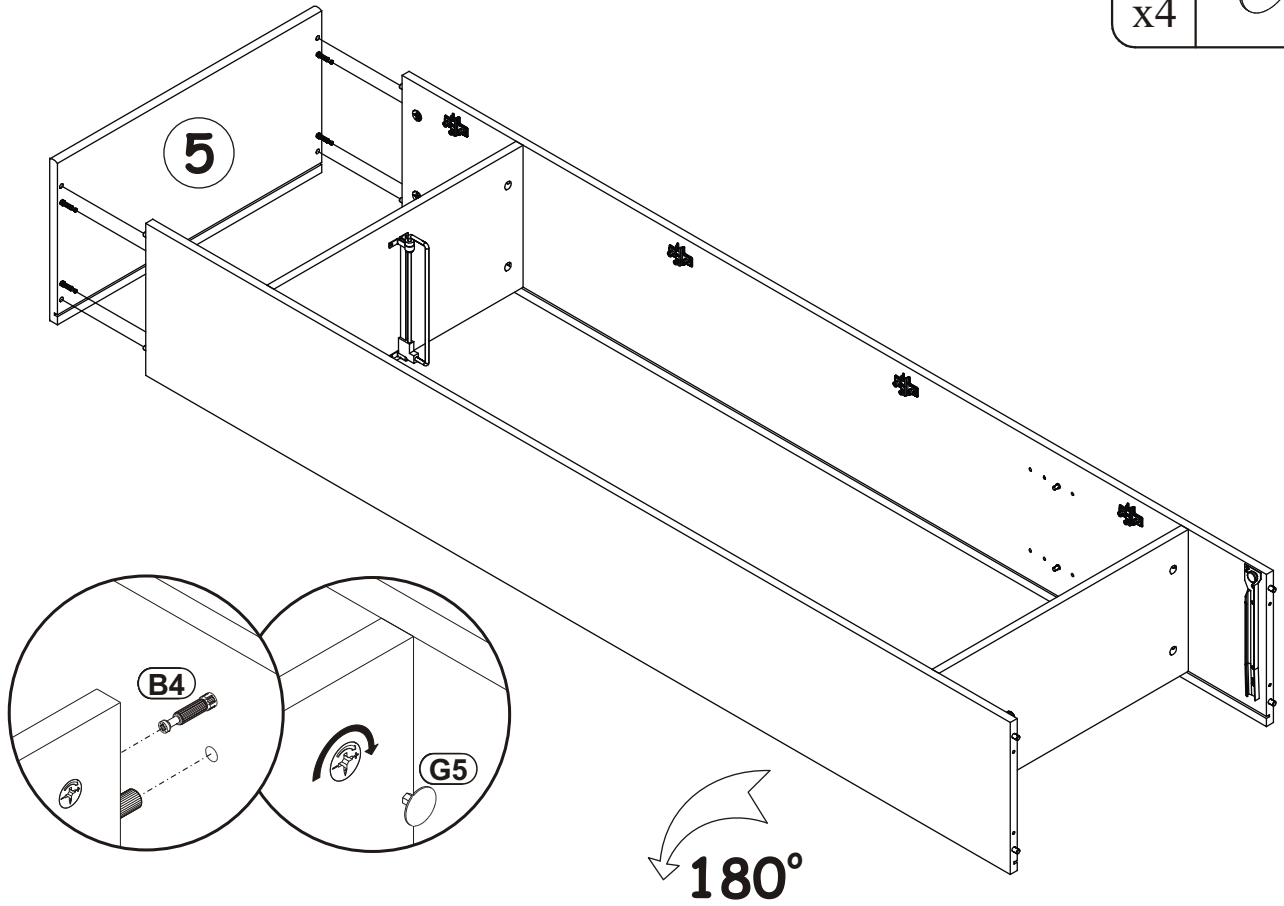

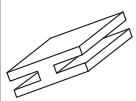

13

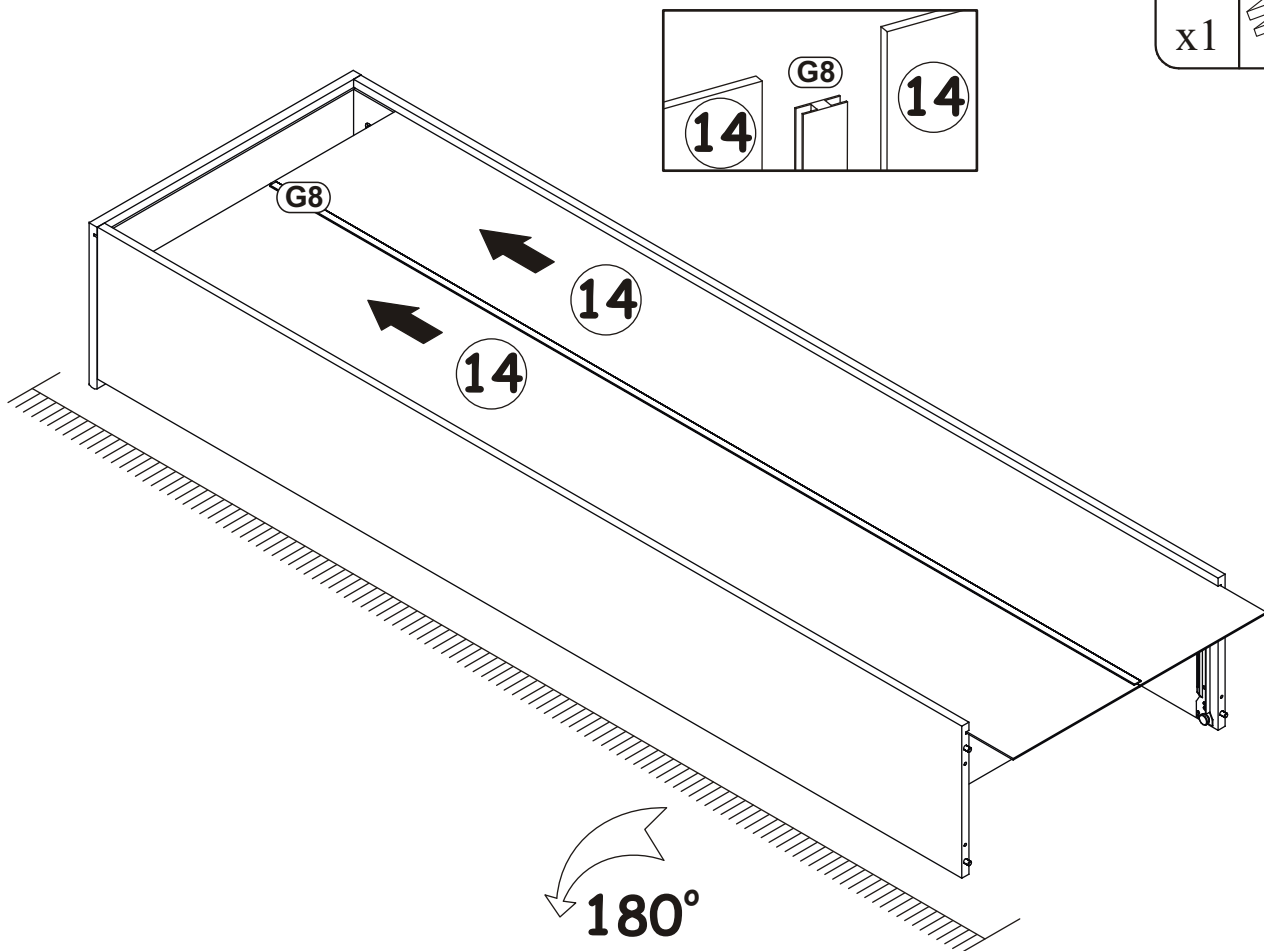
G8	
x1	



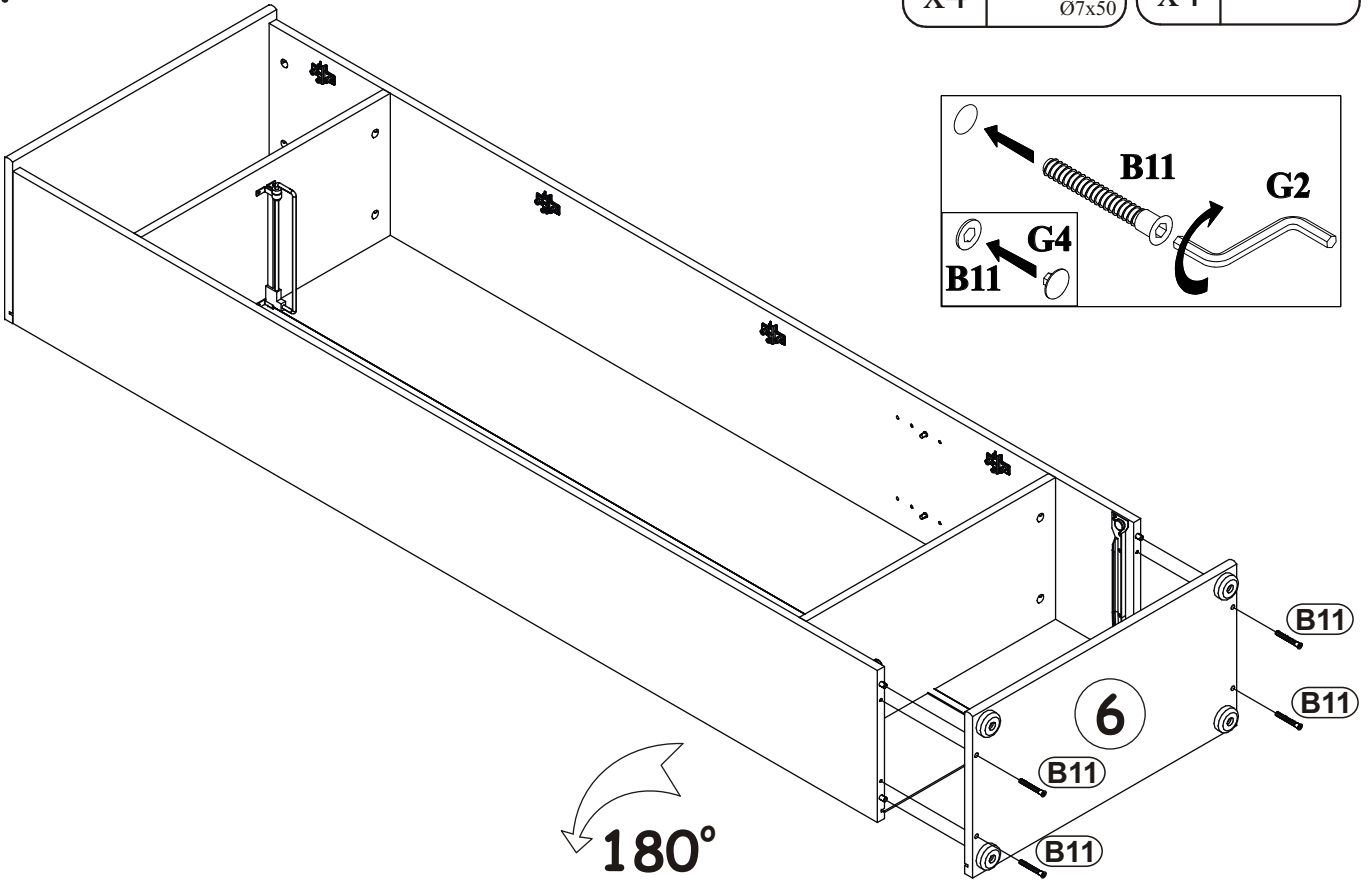
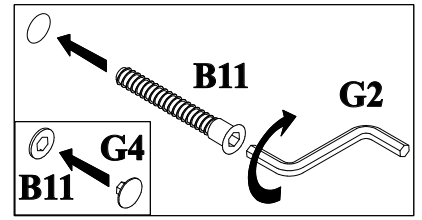

14

B11		G4	
x4	Ø7x50	x4	

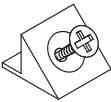

15

S1		B3	
x16		x10	Ø1,4x25

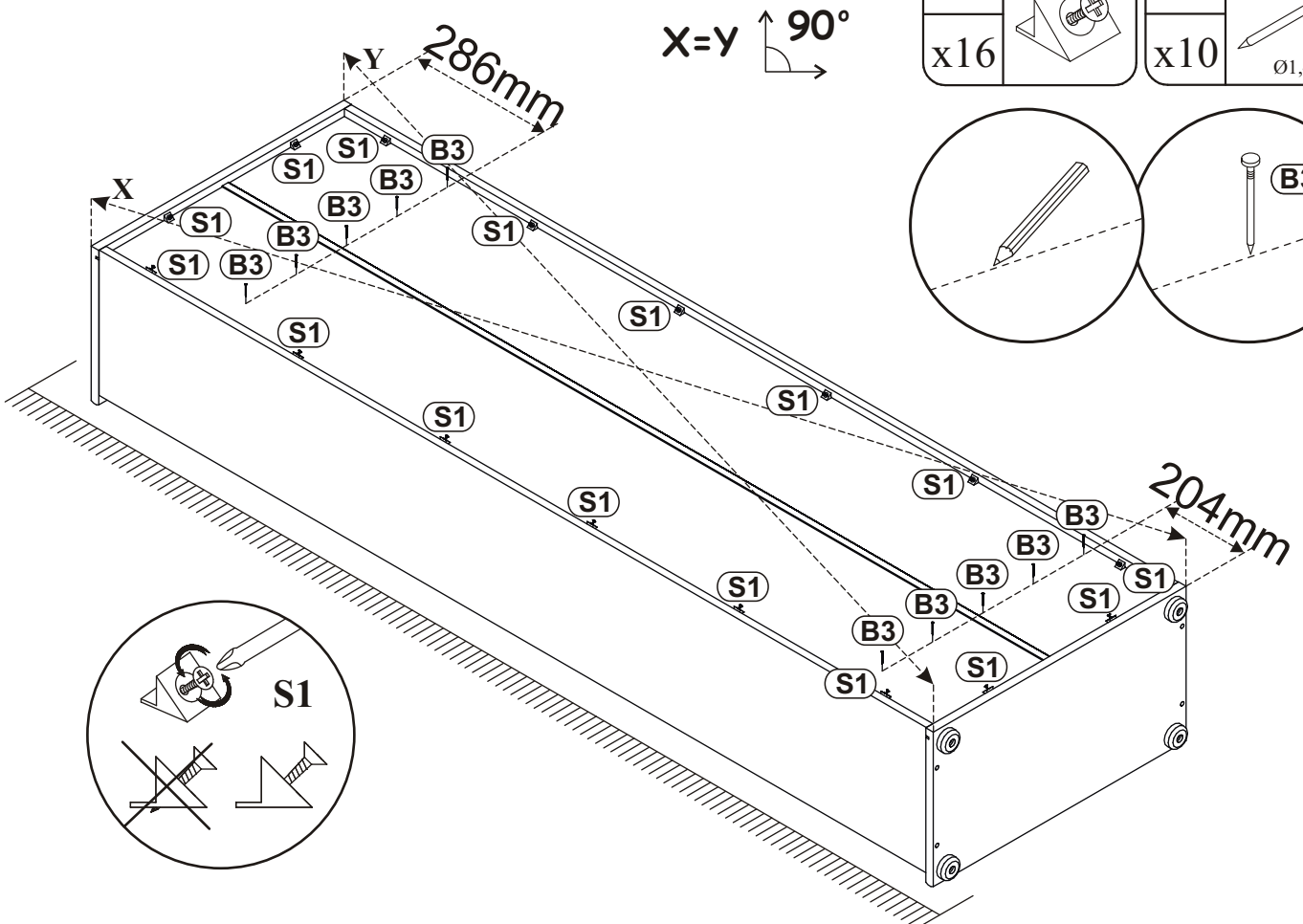
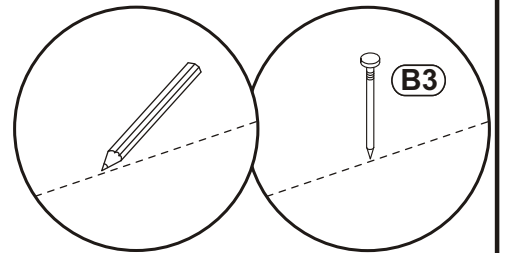

16

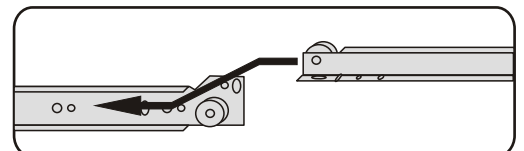
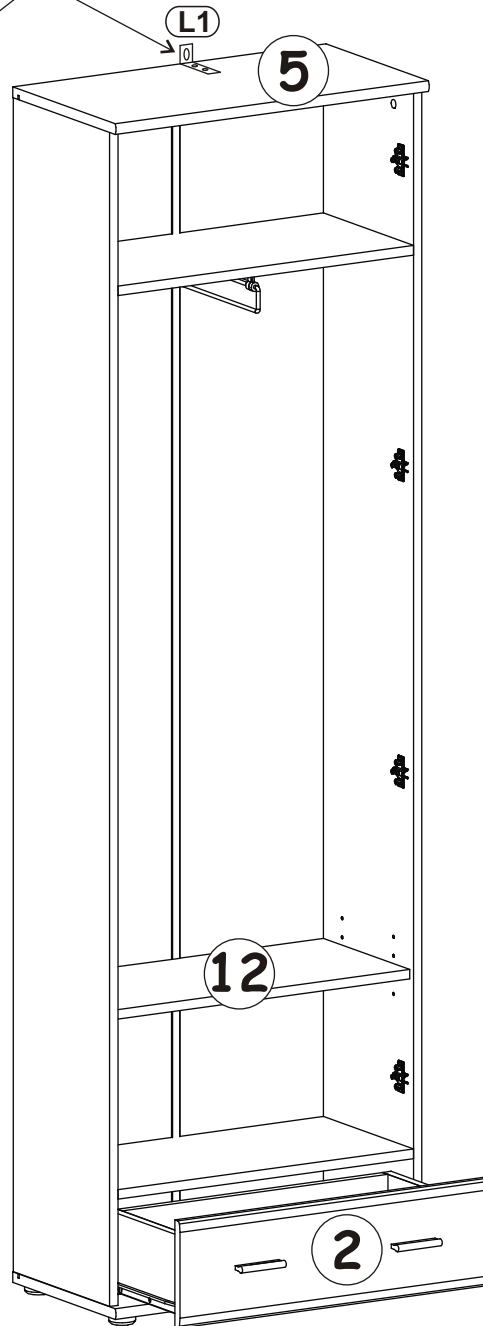
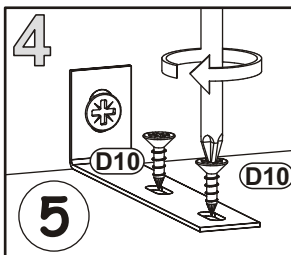
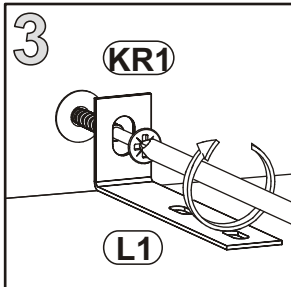
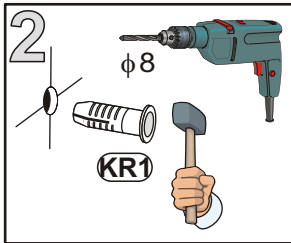
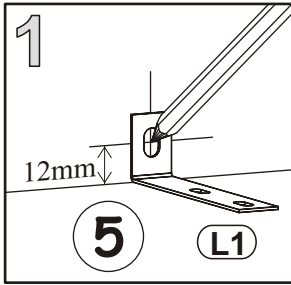
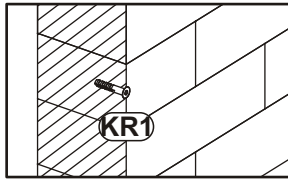
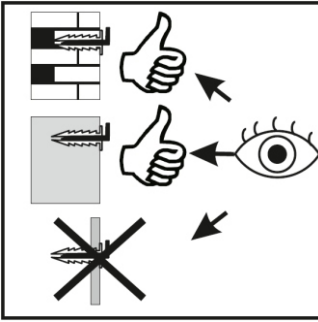
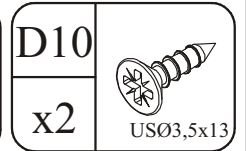
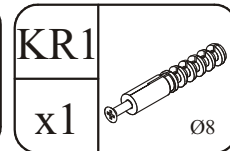
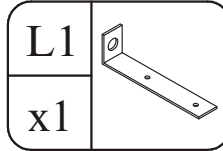

17

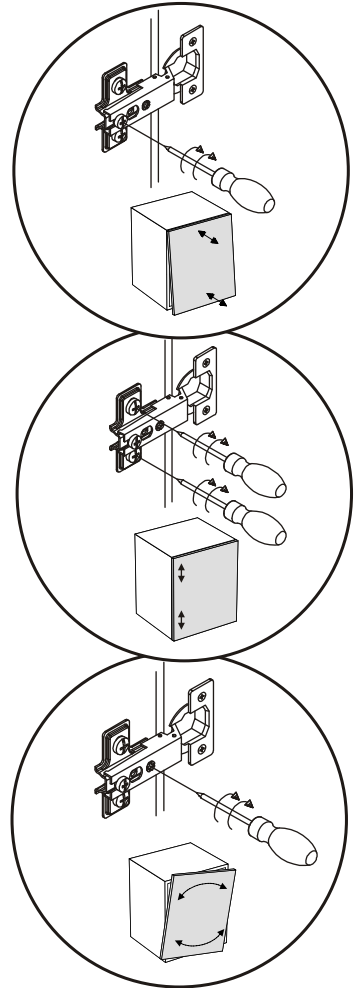
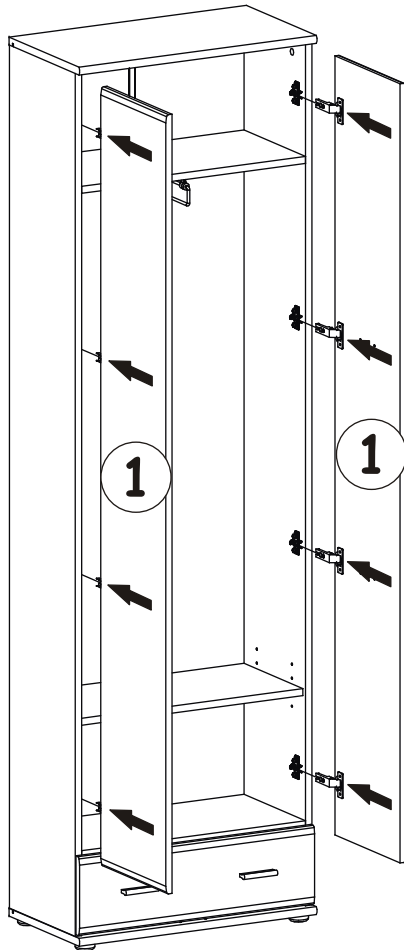

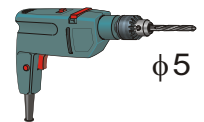
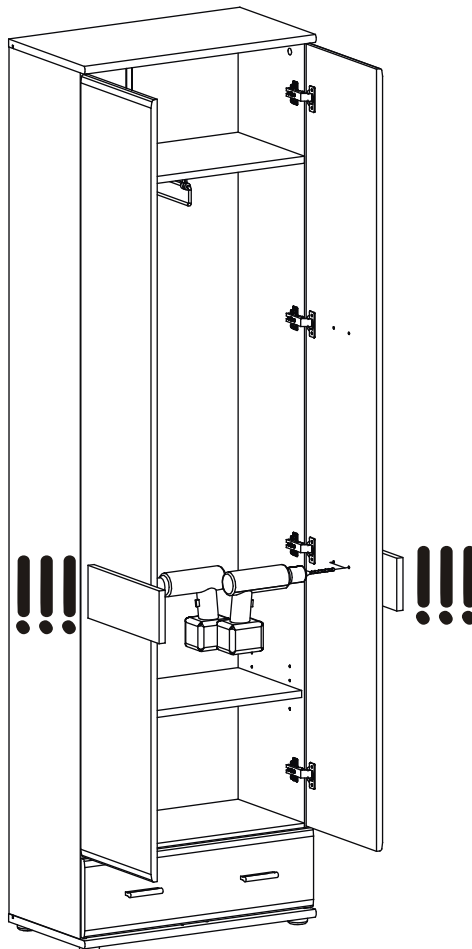

18

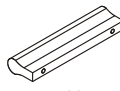

19

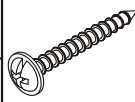
KL	
x2	L-64mm

UP6	
x4	UP04x30

Z2	
x4	Ø5

