







LDC535

HARDWARE LIST			
NO.	PART	DESCRIPTION	Q'TY
A		back	1
B		frame	1
C		caps	4
D		short screw	2
E		long screw	2
F		allen key	1



step 1

step 2

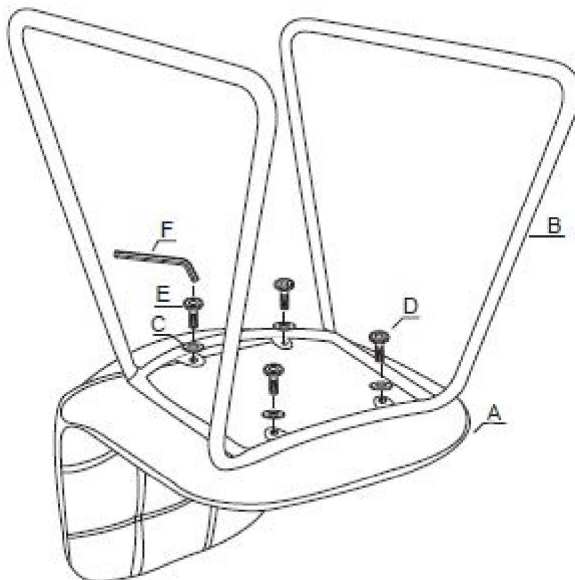

LDC535 1/1