

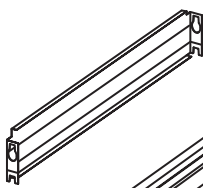

(A)x8



(B)x8



(C)x8

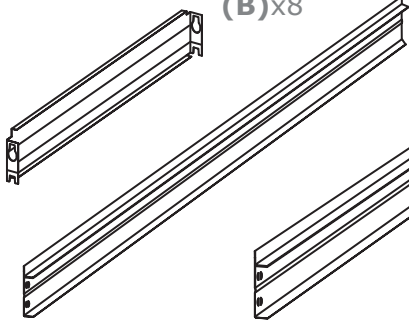

(D)x8

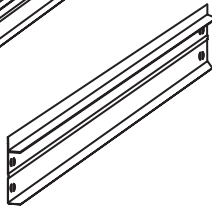

(E)x8



(F)x4



(G)x4



1

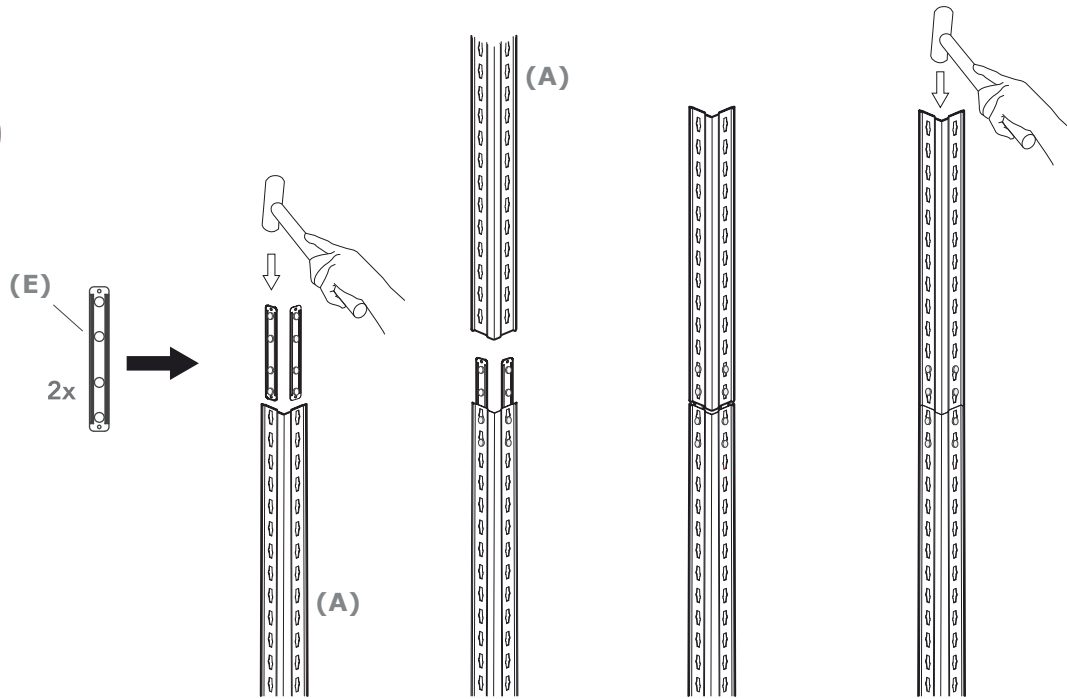

2

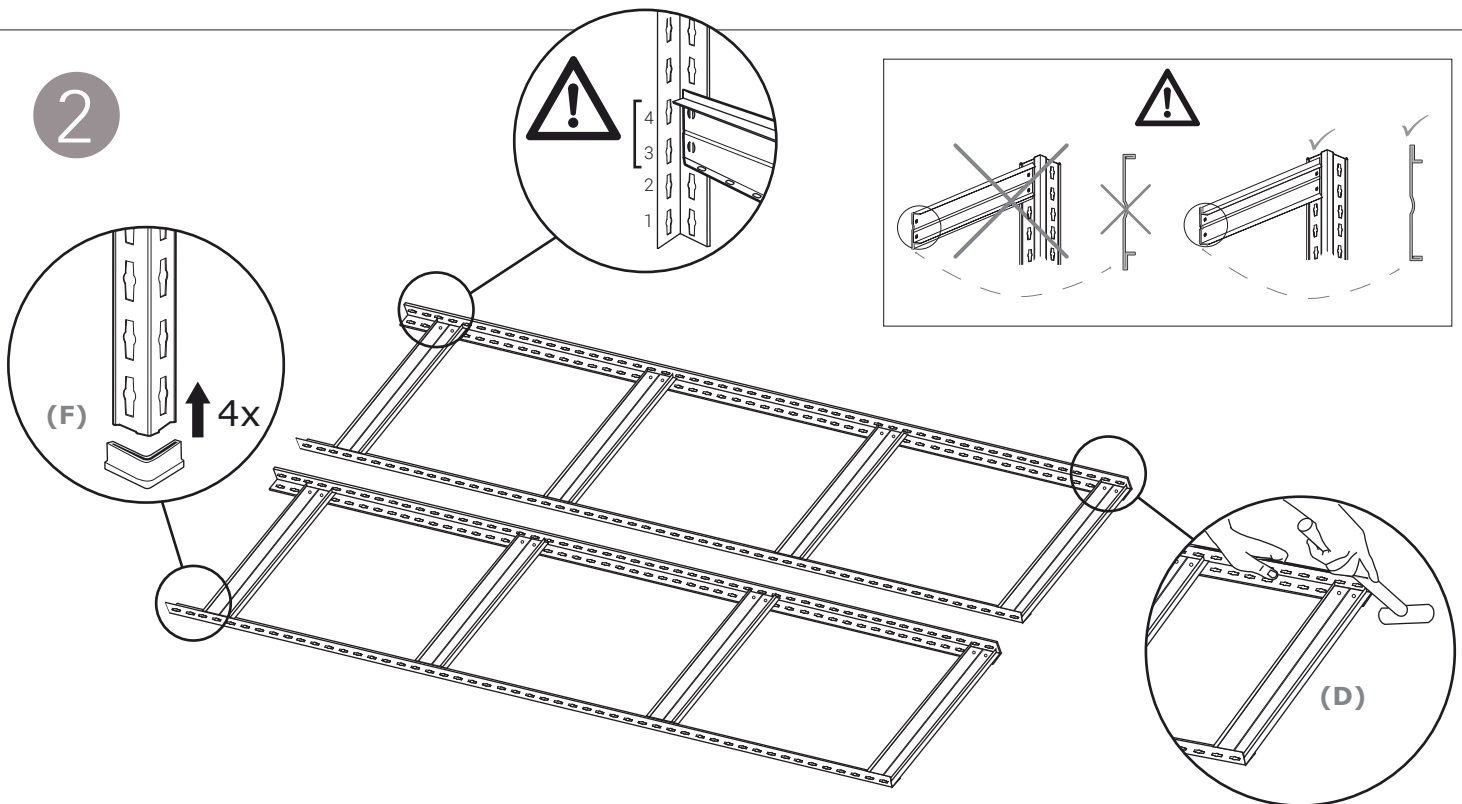

3

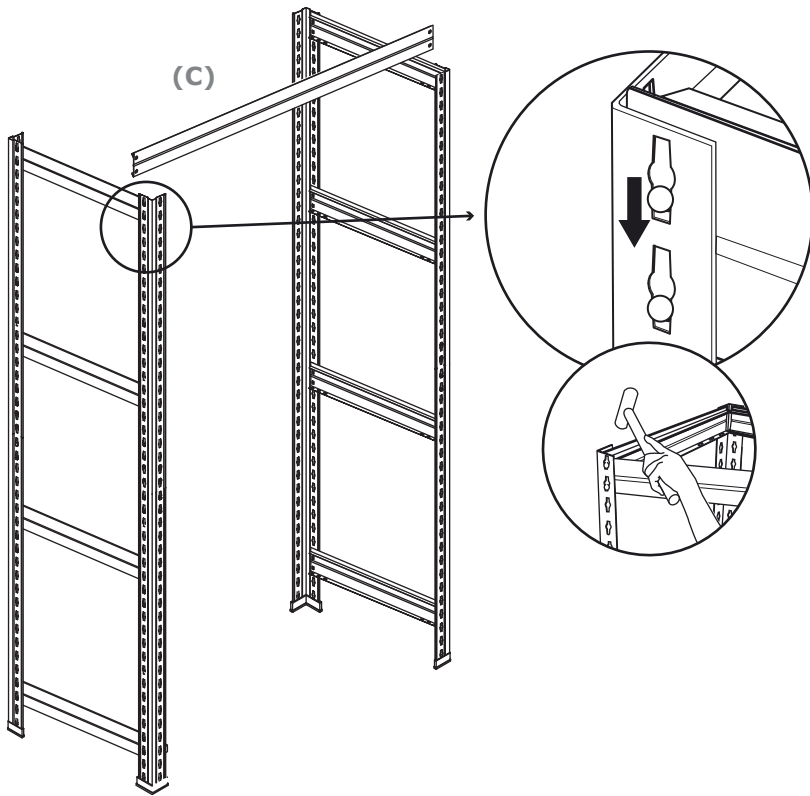

4

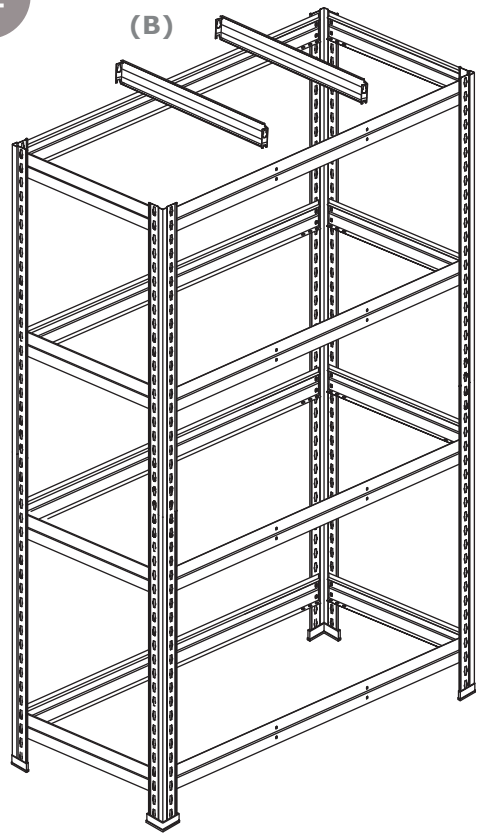

5

